



H 7805

Description

The H7805 series of three terminal positive Regulators are available in the TO-220 package and with several fixed output voltages, making them useful in a wide range of applications. Each type employs internal current limiting, Thermal shut down and safe operating area protection, making it essentially indestructible. If adequate heat sinking is provided, they can deliver over 1A output current. Although designed primarily as fixed voltage regulator, these devices can be used with external components to obtain adjustable voltages and currents.

Features

- Output current up to 1A
- Output Voltages of 5V
- Thermal Overload Protection
- Short Circuit Protection
- Output Transistor Safe Operating Area Protection

Absolute Maximum Ratings ($T_a=25^\circ\text{C}$)

V_I	—Input Voltage (for $V_O=5V$ to 18V).....	35V
R_{JC}	—Thermal Resistance Junction-Cases.....	5 $^\circ\text{C}/\text{W}$
R_{JA}	—Thermal Resistance Junction-Air.....	65 $^\circ\text{C}/\text{W}$
T_{OPR}	—Operating Temperature Range.....	0~125
T_{STG}	—Storage Temperature Range.....	-65~150

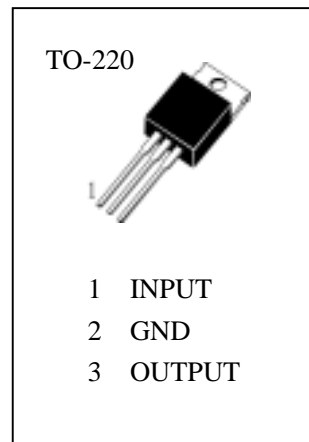

Internal Block Diagram

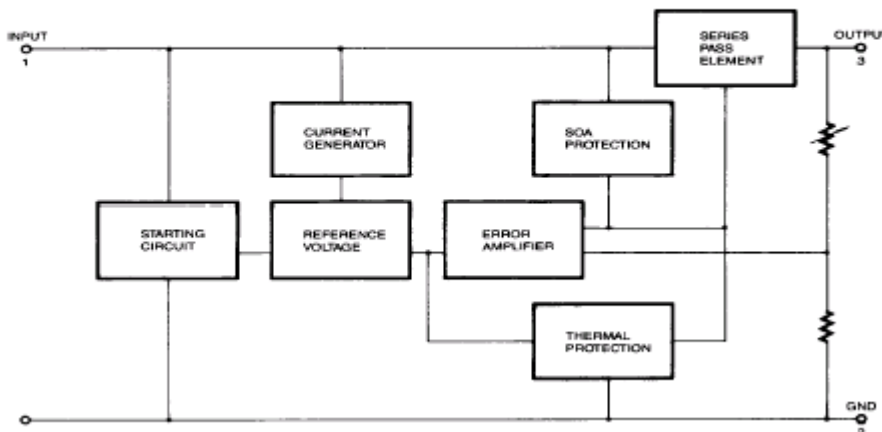



(Refer to test circuit, unless otherwise specified, $T_J = 25^\circ\text{C}$, $I_o = 500\text{mA}$, $V_i = 10\text{V}$, $C_i = 0.33\ \mu\text{F}$, $C_o = 0.1\ \mu\text{F}$,)

Symbol	Parameter	Min.	Typ.	Max.	Unit	Conditions
V_o	Output Voltage	4.8	5.0	5.2	V	$T_J = 25$
		4.75	5.0	5.25		$5.0\text{mA} \leq I_o \leq 1.0\text{A}$, $P_o \leq 15\text{W}$, $7\text{V} \leq V_i \leq 20\text{V}$
V_o	Line Regulation (Note1)		4.0	100	mV	$T_J = 25$, $7\text{V} \leq V_i \leq 25\text{V}$
			1.6	50		$T_J = 25$, $8\text{V} \leq V_i \leq 12\text{V}$
V_o	Load Regulation (Note1)		9	100	mV	$T_J = 25$, $5.0\text{mA} \leq I_o \leq 1.5\text{A}$
			4	50		$T_J = 25$, $250\text{mA} \leq I_o \leq 750\text{mA}$
I_o	Quiescent Current		5.0	8	mA	$T_J = 25$
I_o	Quiescent Current Change		0.03	0.5	mA	$5\text{mA} \leq I_o \leq 1.0\text{A}$
			0.3	1.3		$7\text{V} \leq V_i \leq 25\text{V}$
V_o / T	Output Voltage Drift		-0.8		mV/	$I_o = 5\text{mA}$
V_N	Output Noise Voltage		42		μV	$T_A = 25$, $10\text{Hz} \leq f \leq 100\text{kHz}$
RR	Ripple Rejection	62	73		dB	$f = 120\text{Hz}$, $8\text{V} \leq V_i \leq 18\text{V}$
V_D	Dropout Voltage		2		V	$I_o = 1\text{A}$, $T_J = 25$
R_o	Output Resistance		15		m	$f = 1\text{kHz}$
I_{SC}	Short Circuit Current		230		mA	$V_i = 35\text{V}$, $T_A = 25$
I_{PK}	Peak Current		2.2		A	$T_J = 25$



Typical Applications

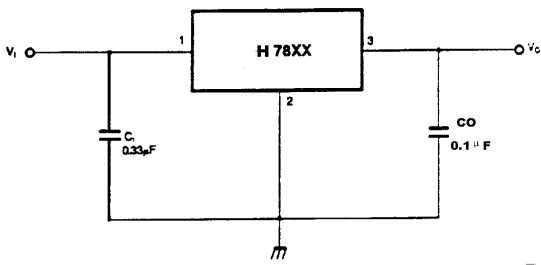

1、 DC Parameters

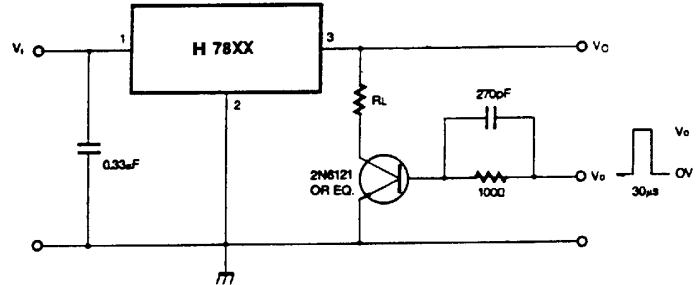

2、 Load Regulation

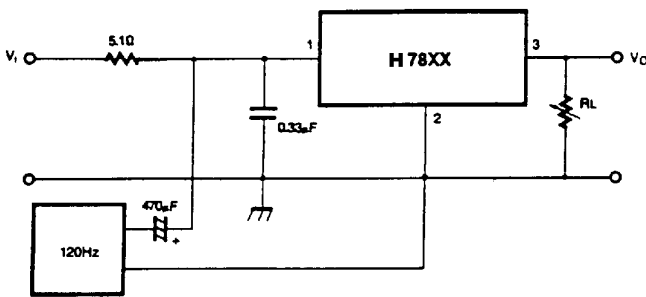

3、 Ripple Rejection

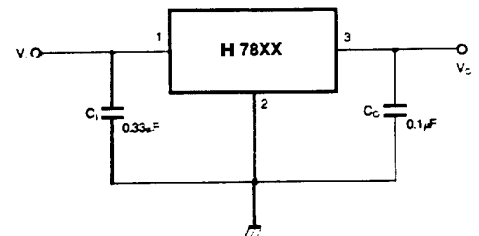

4、 Fixed Output Regulator

Notes:

- (1) To specify an output voltage, substitute voltage value for "XX." A common ground is required between the input and the Output voltage. The input voltage must remain typically 2.0V above the output voltage even during the low point on the input ripple voltage.
- (2) C₁ is required if regulator is located an appreciable distance from power Supply filter.
- (3) C₀ improves stability and transient response.

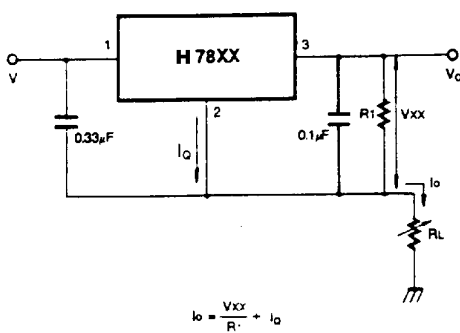

5、 Constant Current Regulator

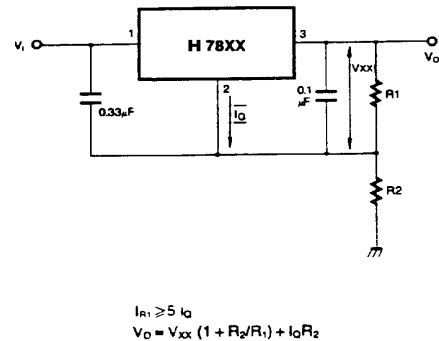

6、 Circuit for Increasing Output Voltage



H 7805

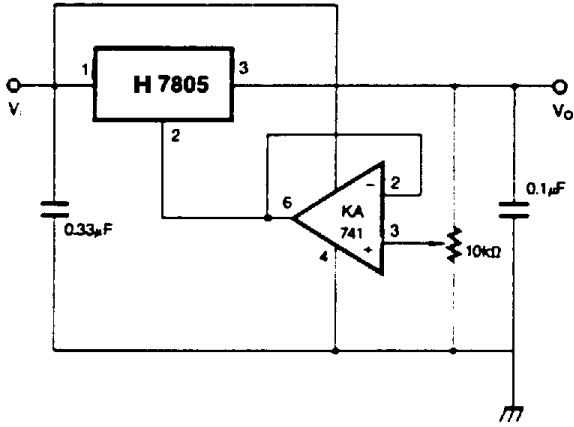

7、 Adjustable Output Regulator (7 to 30V)

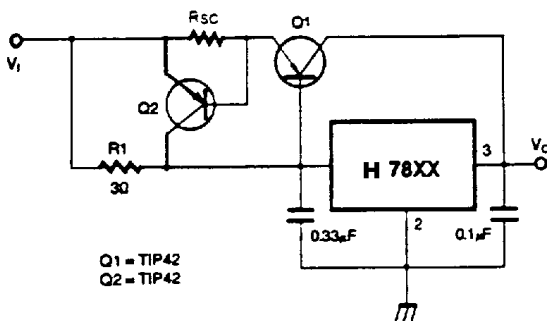

Q1 = TIP42
Q2 = TIP42

$$R_{sc} = \frac{V_{BEQ2}}{I_{sc}}$$

9、 High Output Current with Short Circuit Protection

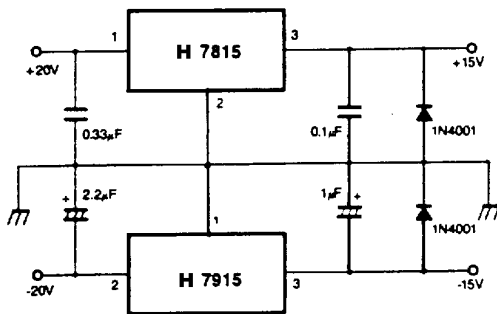

11、 Split Power Supply (±15V-1A)

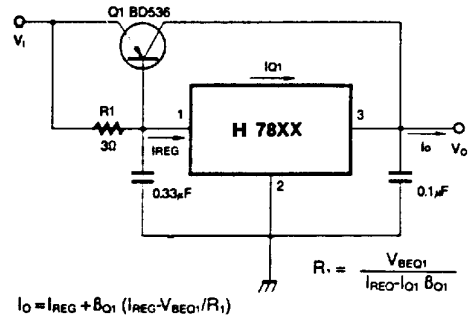

$$I_o = I_{REG} + \beta_{O1} (I_{REG} - V_{BEQ1}/R_1)$$

$$R_1 = \frac{V_{BEQ1}}{I_{REG} - I_{O1} \beta_{O1}}$$

8、 High Current Voltage Regulator

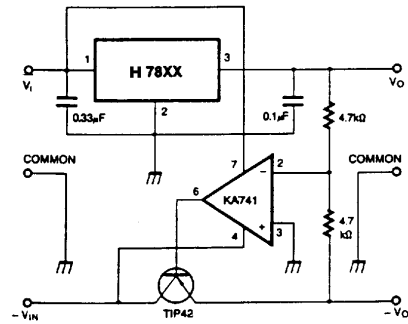

10、 Tracking Voltage Regulator

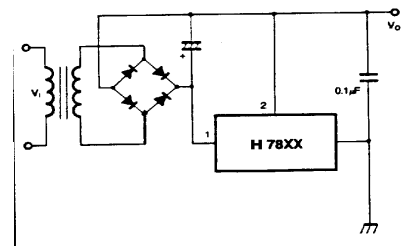

12、 Negative Output Voltage Circuit

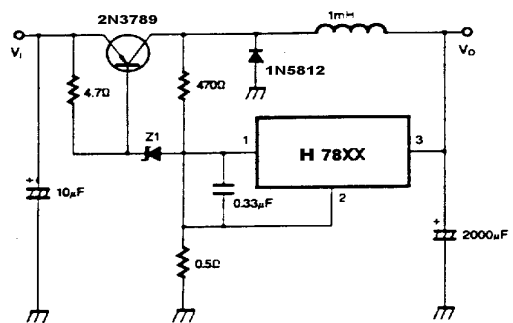

13、 Switching Regulator



Typical Performance Characteristics

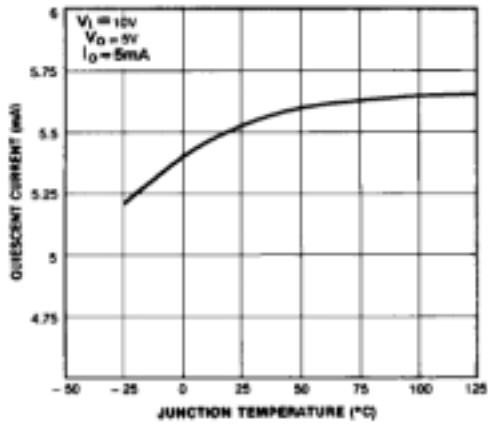

Figure 1. Quiescent Current

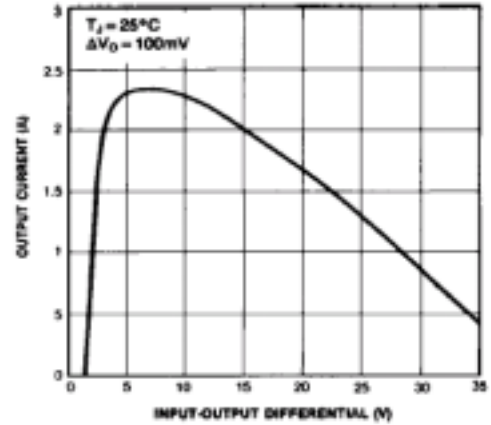

Figure 2. Peak Output Current

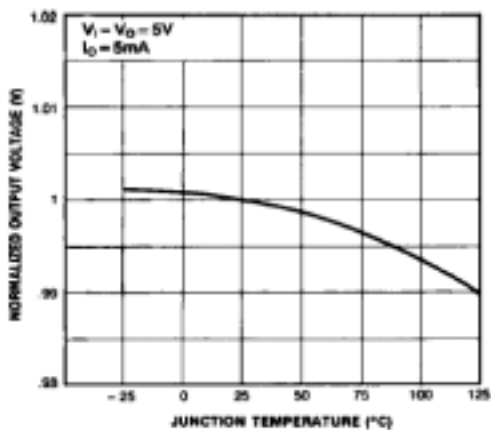

Figure 3. Output Voltage

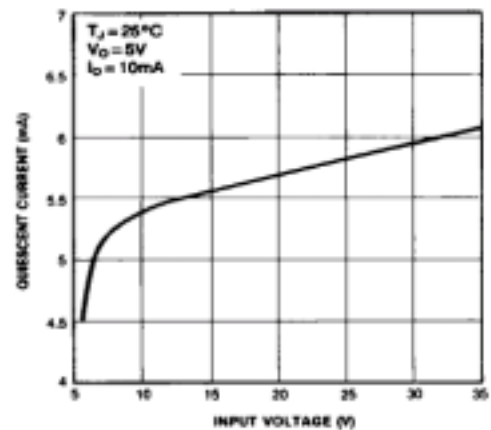

Figure 4. Quiescent Current